

Serie 9000

 9200 Pag. 16.8	 9220 Pag. 16.8	 9230 Pag. 16.8	 9260 Pag. 16.8	 9280 Pag. 16.9	 9460 Pag. 16.9	 9480 Pag. 16.9	 9500 Pag. 16.9	 9550 Pag. 16.10	
 9680 Pag. 16.10	 9740 Pag. 16.10	 10770 Pag. 16.10							

Serie 10000

Fino ad esaurimento scorte - Until the end stock - Nur solange vorrat
 Livrable jusqu'à épuisement du stock - Hasta fin de stock - Ate fim do stock

 10200 Pag. 16.14	 10220 Pag. 16.14	 10230 Pag. 16.14	 10240 Pag. 16.15	 10260 Pag. 16.15	 10280 Pag. 16.15	 10290 Pag. 16.16	 10460 Pag. 16.16	 10465 Pag. 16.16
 10480 Pag. 16.17	 10485 Pag. 16.17	 10500 Pag. 16.18	 10510 Pag. 16.18	 10550 Pag. 16.19	 10680 Pag. 16.19	 10760 Pag. 16.19		

Serie 13000

 13200 Pag. 16.23	 13220 Pag. 16.23	 13230 Pag. 16.23	 13240 Pag. 16.24	 13260 Pag. 16.24	 13280 Pag. 16.24	 13290 Pag. 16.25	 13300 Pag. 16.25	 13460 Pag. 16.25
 13465 Pag. 16.26	 13480 Pag. 16.26	 13483 Pag. 16.26	 13485 Pag. 16.27	 13500 Pag. 16.27	 13510 Pag. 16.27	 13530 Pag. 16.28	 13540 Pag. 16.28	 13550 Pag. 16.28
 13550BI Pag. 16.29	 13570BI Pag. 16.29	 13958BI Pag. 16.29	 13600 Pag. 16.30	 13680 Pag. 16.30	 13740 Pag. 16.30	 13780 Pag. 16.30	 10740 Pag. 16.31	 10770 Pag. 16.31
 1612 Pag. 16.31	 1613 Pag. 16.31	 13800 Pag. 16.32	 13805 Pag. 16.33	 13810 Pag. 16.33	 13820 Pag. 16.34	 13825 Pag. 16.34	 TBPL Pag. 16.35	

RACCORDI UNIVERSALI

UNIVERSAL FITTINGS

UNIVERSAL VERSCHRAUBUNGEN

RACCORDS UNIVERSELS

RACORDAJE UNIVERSAL

CONEXÕES UNIVERSAIS

Serie 13000





CARATTERISTICHE TECNICHE

TECHNICAL CHARACTERISTICS
TECHNISCHE ANGABEN
CARACTÉRISTIQUES TECHNIQUES
CARACTERÍSTICAS TÉCNICAS
CARACTERÍSTICAS TÉCNICAS



Norma di Riferimento

Reference standard
Entspricht der Norm
Norme de référence
Normativa de referencia
Norma de referència

1907/2006
REACH ✓

2011/65/CE
RoHS ✓

UNI EN 1254
2:2000

PED
2014/68/UE

**SILICON
FREE**

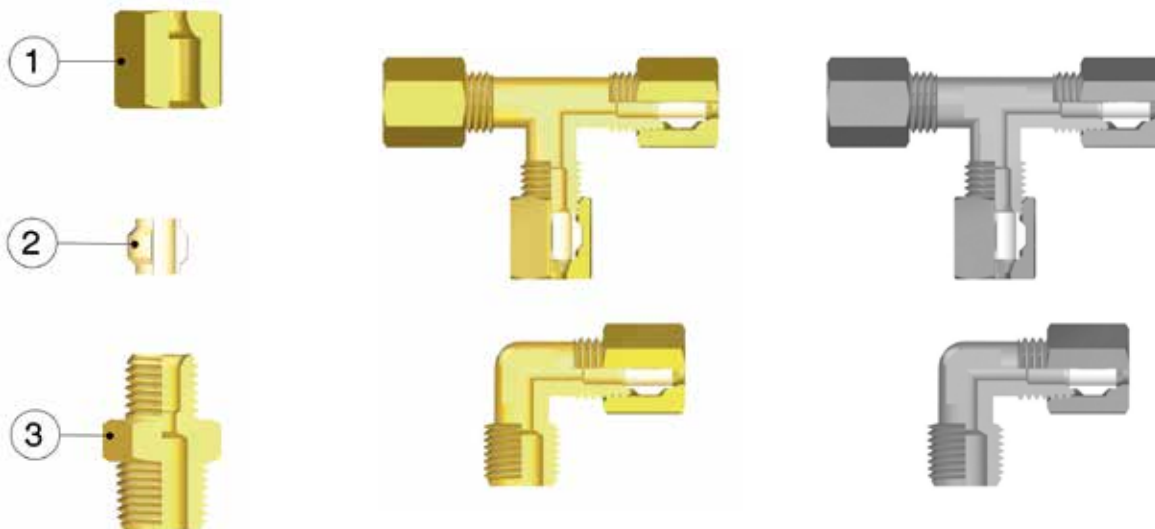

Materiali e Componenti	IT	Component Parts and Materials	GB	Komponenten und Materialien	DE
1 Dado in Ottone / Ottone Nichelato 2 Ogiva in Ottone 3 Corpo in Ottone / Ottone Nichelato		1 Nut Brass / Nickel-plated Brass 2 Brass Olive 3 Body Brass / Nickel-plated Brass		1 Übrwurfmutter Messing / Vernickeltes Messing 2 Klemmring Messing 3 Körper Messing / Vernickeltes Messing	
Matériaux et Composants	FR	Materiales y Componentes	ES	Materiais e Componentes	PT
1 Ecrou: Laiton / Laiton nickelé 2 Bague: Laiton 3 Corps: Laiton / Laiton nickelé		1 Tuerca en Latón / Latón niquelado 2 Bicoño en Latón 3 Cuerpo en Latón / Latón niquelado		1 Porca em Latão / Latão niquelado 2 Bucha em Latão 3 Corpo em Latão / Latão niquelado	



Tubi di Collegamento	IT	Connection Tubes	GB	Geeignete Rohre	DE
Tubi in rame, ferro, acciaio, alluminio, ottone, PA.		Tubes made in copper, steel, iron, aluminium, brass, PA.		Rohre in Kupfer, Eisen, Stahl, Aluminium, Messing, PA.	
Tubes Conseillés	FR	Tubos de Conexión	ES	Tubos de Conexão	PT
Tubes en cuivre, acier, aluminium, laiton, PA.		Tubos en cobre, hierro, acero, aluminio, latón, PA.		Tubos de cobre, ferro, aço, alumínio, latão, PA.	



Filettatura	IT	Threads	GB	Gewindearten	DE
Gas conica conforme ISO 7.1, BS 21, DIN 2999. Gas cilindrica conforme ISO 228 Classe A. Metrica conforme ISO R/262.		Tapered gas in conformity with ISO 7.1, BS 21, DIN 2999. Parallel gas in conformity with ISO 228 Class A. Metric in conformity with ISO R/262.		Konisches Gewinde nach Norm ISO 7.1, BS 21, DIN 2999. Zylindrisches Gewinde nach Norm ISO 228 Classe A. Metrisches Gewinde nach Norm ISO R/262.	
Filetages	FR	Roscas	ES	Roscas	PT
Filetage conique conforme: ISO 7.1, BS 21, DIN 2999. Filetage cylindrique conforme: ISO 228 Class A. Filetage métrique conforme: ISO R/262.		Gas cónica conforme ISO 7.1, BS 21, DIN 2999. Gas cilíndrica conforme ISO 228 Clase A. Métrica conforme ISO R/262.		Gas cónica conforme ISO 7.1, BS 21, DIN 2999. Gas paralela conforme ISO 228 Classe A. Métrica conforme ISO R/262.	



Pressioni e Temperature

IT

Pressioni e temperature vengono determinate dal tipo di tubo impiegato, pertanto tali valori sono da definirsi in base alle caratteristiche del tubo stesso.

Riportiamo di seguito i valori delle pressioni massime consigliate per l'utilizzo dei raccordi con tubi di rame dallo spessore di 1 mm a 20° C.

I valori delle pressioni consigliate, riportate in tabella, sono stati ottenuti dai valori di prova adottando un Coefficiente di Sicurezza 4.

Sono disponibili i certificati delle prove rilasciati dai vari laboratori che le hanno eseguite.

Pressures and Temperatures

GB

The working pressures and working temperatures depend on which type of tube is used, for this reason, the values must be determined in accordance with the tube's features.

Hereunder, we specify the values of the maximum pressure advised for the fittings at a temperature of 20° C connected with copper tube, which has a thickness of 1 mm.

The values of working pressures advised, specified in table have been obtained from the test values using a Safety Factor 4.

It is available the test report made by the external laboratory test.

Druckbereich und Temperatur

DE

Drücke und Temperaturen sind definiert durch die verwendete Ausführung der Leitung, d.h. die Werte der eingesetzten Rohre sind zu beachten.

Nachfolgend geben wir die Werte des maximalen Druckes für den Einsatz der Verschraubungen mit Kupferrohren an, deren Wandstärke min. 1mm beträgt und bei einer Temperatur von 20° C.

Es muss berücksichtigt werden, dass die angegebenen Druckwerte in der Tabelle mit einem Sicherheitsfaktors von 4 berechnet wurden.

Es stehen Prüfberichte zur Verfügung, die von verschiedenen, externen Labors gemacht wurden.

Pressions et Températures

FR

type de tube utilisé. Pour cette raison, les valeurs doivent être déterminées en conformité avec les caractéristiques du tube. Ci-dessous, nous indiquons les valeurs de la pression maximale recommandée pour une connexion avec un tube en cuivre de 1 mm d'épaisseur à une température de 20° C.

Les pressions de service indiquées ont été calculées avec un coefficient de sécurité de 4.

Des rapports externes de tests sont disponibles sur demande pour attester ces valeurs.

Presiones y Temperaturas

ES

Presión y temperatura vienen determinadas según el tipo de tubo empleado, por lo tanto estos valores se definen en base a las características del mismo tubo. Representamos a continuación los valores de las presiones máximas aconsejadas para la utilización de los racores con tubo de cobre espesor 1 mm a 20° C.

Los valores de las presiones aconsejadas, representadas en la tabla, han sido obtenidas de valores de prueba adoptando un coeficiente de seguridad 4.

Están disponibles los certificados de las pruebas realizadas en distintos laboratorios especializados.

Pressões e Temperaturas

PT

Pressões e temperaturas dependem do tipo de tubo aplicado, portanto tais valores devem ser definidos com base nas características do tubo em questão.

A seguir apresentamos os valores das pressões máximas aconselhadas para a utilização das conexões com tubos de cobre de espessura de 1 mm a 20° C.

Os valores das pressões aconselhadas, reportados na tabela, foram obtidas dos valores de teste adotando-se um Coeficiente de Segurança 4.

Os certificados de teste executados por laboratórios externos estão disponíveis.



Temperature

Temperatures

Temperatur

Températures

Temperaturas

Temperaturas

- 60 °C

+ 300 °C

Misura Size Größe Dimension Tamaño Tamanho	Pressione massima consigliata a 20 °C Maximum pressure advised at 20 °C Maximal Empfohlener Druck bei 20 °C Pression maximum conseillée à 20 °C Presión máxima aconsejada a 20 °C Pressão máxima aconselhada a 20 °C
Ø	kg/cm ² bar
4	150 148.4
6	150 148.4
8	135 133.6
10	95 94
12	75 74.2
14	100 99
15	95 94
16	95 94
18	70 69.3
22	70 69.3



Fluidi compatibili

Acqua / Olio / Aria compressa

Fluidi in genere per l'impiantistica idraulica, oleodinamica, idropneumatica, ecc.

Fluids

Water / Oils / Compressed air

Fluids in general for the hydraulic, pneumatic and oil dynamic plants etc.

Geeignete Medien

Wasser / Oel / Druckluft

Medien im Allgemeinen für hydraulische-, hydro-pneumatische- und pneumatische Anlagen, usw.

Fluides compatibles

Eau / Huile / Air comprimé

Fluides courants utilisés en hydraulique et pneumatique, etc.

Fluidos compatibles

Agua / Aceite / Aire comprimido

Fluidos en general para los campos hidráulicos, neumáticos y oleodinámicos, etc.

Fluidos compatíveis

Água / Oleo / Ar comprimido

Fluidos em geral para aplicações hidráulicas, oleodinâmicas, hidropneumáticas, etc.



Coppia di serraggio

Torque specifications

Angaben Drehmoment

Couple de serrage

Par de apriete

Especificações de Torque

COPPIE DI SERRAGGIO DADO SU OGIVA TORQUE FORCE ON OLIVE NUT ANZUGSDREHMOMENT ZWISCHEN MUTTER UND KLEMMRING COUPLE DE SERRAGE DE L'ECROU SUR LA BAGUE OLIVE PAR DE APRIETE DE LA TUERCA DE OJIVA TORQUE DE APERTO PARA PORCA EM BUCHA			
Ø	N° Giri chiave N° Key turns N° Schlüssel Umdrehungen N° de tours N° Giro de la tuerca N° Rotação da porca	Forza Force Drehmoment Couple Fuerza Força	Forza Force Drehmoment Couple Fuerza Força
mm		Nm	kgf
4	1 1/4 + 1/4	15	1.55
6	1 1/4 + 1/4	18	1.85
8	1 1/4 + 1/4	22	2.25
10	1 1/4 + 1/4	45	4.6
12	1 1/4 + 1/4	70	7.15
14	1 1/4 + 1/4	80	8.15
15	1 + 1/4	90	9.2
16	1 + 1/4	90	9.2
18	1 + 1/4	140	14.3
22	1 + 1/4	160	16.3

Forze di serraggio, minime consigliate, e n° di giri utili, per garantire un montaggio corretto.
Torque force, minimum recommended, and useful turn, to ensure a correct installation.
Empfohlenes Anzugsdrehmoment und mindest Umdrehungszahl für eine korrekte montage.
Couple de serrage minimum recommandé et nombre de tours pour assurer une installation correcte.
Par de apriete mínimo recomendado y n. giros necesarios para garantizar un montaje correcto.
Torque de aperto mínimo garantido, n. rotação necessário para garantir a correcta instalação.

13200

RACCORDO A T INTERMEDIO

TEE CONNECTOR

T-ANSCHLUSS

RACCORD TÉ

RACOR A T INTERMEDIO

CONEXÃO EM "T" TUBO-TUBO

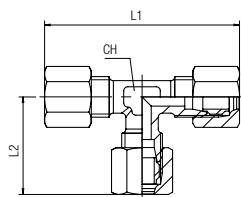

Code Brass	Code Nickel Plated Brass	Tube	L1	L2	CH	Pack.
13200 00 001	13200 00 011	4	44	22	8	10
13200 00 002	13200 00 012	6	48	24	9	10
13200 00 003	13200 00 013	8	57	28.5	12	10
13200 00 004	13200 00 014	10	64	32	13	10
13200 00 005	13200 00 015	12	69	35	14	10
13200 00 006	13200 00 016	14	78	39	18	10
13200 00 007	13200 00 017	15	77	38.5	18	10
13200 00 008	13200 00 018	16	78.5	39.5	17	10
13200 00 009	13200 00 019	18	83	41.5	20	10
13200 00 010	13200 00 020	22	89	44.5	27	10

13220

RACCORDO A T MASCHIO CENTRALE

TEE MALE ADAPTOR CENTRE LEG

T-EINSCHRAUBVERSCHRAUBUNG KONISCH

TÉ À PIQUAGE MÂLE CENTRAL, CONIQUE

RACOR A T MACHO CENTRAL

CONEXÃO EM "T" COM ROSCA MACHO CENTRAL

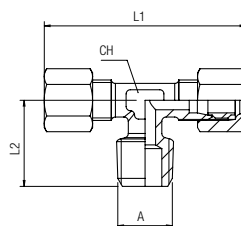

Code Brass	Code Nickel Plated Brass	Tube	A	L1	L2	CH	Pack.
13220 00 001	13220 00 020	4	1/8	45	15	8	10
13220 00 002	13220 00 021	6	1/8	48	16.5	9	10
13220 00 003	13220 00 022	6	1/4	48	20.5	9	10
13220 00 004	13220 00 023	8	1/8	57	16.5	12	10
13220 00 005	13220 00 024	8	1/4	57	20.5	12	10
13220 00 006	13220 00 025	8	3/8	61	23	13	10
13220 00 007	13220 00 026	10	1/4	64	22.5	13	10
13220 00 008	13220 00 027	10	3/8	64	23.5	13	10
13220 00 009	13220 00 028	10	1/2	68	27	14	10
13220 00 010	13220 00 029	12	1/4	69	24.5	14	10
13220 00 011	13220 00 030	12	3/8	69	25	14	10
13220 00 012	13220 00 031	12	1/2	69	26.5	14	10
13220 00 013	13220 00 032	14	3/8	74	26	16	10
13220 00 014	13220 00 033	14	1/2	77	31	18	10
13220 00 015	13220 00 034	15	1/2	78	31	18	10
13220 00 016	13220 00 035	16	1/2	78.5	28	17	10
13220 00 017	13220 00 036	18	1/2	83	29.5	20	10
13220 00 018	13220 00 037	18	3/4	83	32.5	20	10
13220 00 019	13220 00 038	22	3/4	89	34	27	10

13230

RACCORDO A T MASCHIO LATERALE

TEE MALE ADAPTOR OFF SET LEG

L-EINSCHRAUBVERSCHRAUBUNG KONISCH

TÉ À PIQUAGE LATÉRAL, CONIQUE

RACOR A T MACHO LATERAL

CONEXÃO EM "T" COM ROSCA MACHO LATERAL

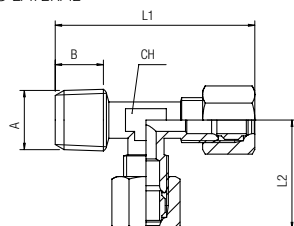

Code Brass	Code Nickel Plated Brass	Tube	A	L1	L2	CH	Pack.
13230 00 001	13230 00 012	4	1/8	37.5	22.5	8	10
13230 00 002	13230 00 013	6	1/8	40	25	9	10
13230 00 003	13230 00 014	6	1/4	44	24	9	10
13230 00 004	13230 00 015	8	1/8	45.5	28.5	12	10
13230 00 005	13230 00 016	8	1/4	49	28.5	12	10
13230 00 006	13230 00 017	8	3/8	52	28.5	13	10
13230 00 007	13230 00 019	10	1/4	55	32	13	10
13230 00 008	13230 00 020	10	3/8	55.5	32	13	10
13230 00 009	13230 00 021	12	3/8	58.5	35	14	10
13230 00 010	13230 00 022	12	1/2	60	35.5	15	10
13230 00 011	13230 00 023	14	1/2	67	38.5	18	10

13240

RACCORDO A T FEMMINA CENTRALE

TEE FEMALE CENTRE LEG

T-EINSCHRAUBVERSCHRAUBUNG INNENGEWINDE

TÉ FEMELLE CENTRAL

RACOR A T HEMBRA CENTRAL

CONEXÃO EM "T" COM ROSCA FÊMEA CENTRAL

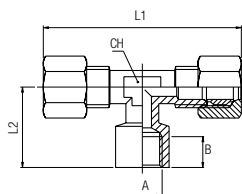

Code Brass	Code Nickel Plated Brass	Tube	A	B	L1	L2	CH	Pack.
13240 00 001	13240 00 019	4	1/8	8.5	45	18	8	10
13240 00 002	13240 00 020	6	1/8	8.5	47.5	19.5	9	10
13240 00 003	13240 00 021	6	1/4	11	56	24.5	13	10
13240 00 004	13240 00 022	8	1/8	8.5	57	19.5	12	10
13240 00 005	13240 00 023	8	1/4	11	59	24.5	13	10
13240 00 007	13240 00 024	10	1/4	11	64	24.5	13	10
13240 00 008	13240 00 025	10	3/8	10.5	58	26	14	10
13240 00 009	13240 00 026	10	1/2	10.5	69	26	15	10
13240 00 010	13240 00 027	12	1/4	11	69	25.5	14	10
13240 00 011	13240 00 028	12	3/8	10.5	69	26	14	10
13240 00 012	13240 00 029	12	1/2	10.5	70	26	15	10
13240 00 013	13240 00 030	14	1/2	10.5	77	30	18	10
13240 00 014	13240 00 031	15	1/2	10.5	78	30	18	10
13240 00 015	13240 00 032	16	1/2	10.5	77.5	28.5	17	10
13240 00 016	13240 00 033	18	1/2	10.5	83	28	20	10
13240 00 017	13240 00 034	18	3/4	14	83	34	20	10

13260

RACCORDO A L INTERMEDIO

ELBOW CONNECTOR

WINKELVERSCHRAUBUNG

RACCORD EQUERRE

RACOR A L INTERMEDIO

CONEXÃO EM "L" TUBO-TUBO

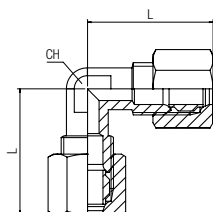

Code Brass	Code Nickel Plated Brass	Tube	L	CH	Pack.
13260 00 001	13260 00 011	4	21.5	8	10
13260 00 002	13260 00 012	6	24	9	10
13260 00 003	13260 00 013	8	30	11	10
13260 00 004	13260 00 014	10	33	13	10
13260 00 005	13260 00 015	12	36	14	10
13260 00 006	13260 00 016	14	37	17	10
13260 00 007	13260 00 017	15	38	17	10
13260 00 008	13260 00 018	16	39.5	17	10
13260 00 009	13260 00 019	18	41.5	20	10
13260 00 010	13260 00 020	22	44.5	27	10

13280

RACCORDO A L MASCHIO

ELBOW MALE ADAPTOR

WINKELVERSCHRAUBUNG KONISCH

EQUERRE MÂLE, CONIQUE

RACOR A L MACHO

CONEXÃO EM "L" COM ROSCA MACHO

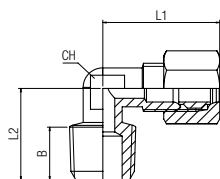

Code Brass	Code Nickel Plated Brass	Tube	A	L1	L2	CH	Pack.
13280 00 001	13280 00 020	4	1/8	21.5	15	8	10
13280 00 002	13280 00 021	6	1/8	24	17	9	10
13280 00 003	13280 00 022	6	1/4	24	19	9	10
13280 00 004	13280 00 023	8	1/8	30	18	11	10
13280 00 005	13280 00 024	8	1/4	30	21.5	11	10
13280 00 006	13280 00 025	8	3/8	30.5	24	13	10
13280 00 007	13280 00 026	10	1/4	33	23.5	13	10
13280 00 008	13280 00 027	10	3/8	33	24.5	13	10
13280 00 009	13280 00 028	10	1/2	35	25	14	10
13280 00 010	13280 00 029	12	1/4	36	24	14	10
13280 00 011	13280 00 030	12	3/8	36	26	14	10
13280 00 012	13280 00 031	12	1/2	36	25	14	10
13280 00 013	13280 00 032	14	3/8	39	26	17	10
13280 00 014	13280 00 033	14	1/2	39	28.5	17	10
13280 00 015	13280 00 034	15	1/2	39	28.5	17	10
13280 00 016	13280 00 035	16	1/2	40	28	17	10
13280 00 017	13280 00 036	18	1/2	41.5	29.5	20	10
13280 00 018	13280 00 037	18	3/4	41.5	32	20	10
13280 00 019	13280 00 038	22	3/4	44.5	34	27	10

13290

RACCORDO A L FEMMINA

ELBOW FEMALE ADAPTOR
 WINKELVERSCHRAUBUNG INNENGEWINDE
 EQUERRE FEMELLE
 RACOR A L HEMBRA
 CONEXÃO EM "L" COM ROSCA FÊMEA

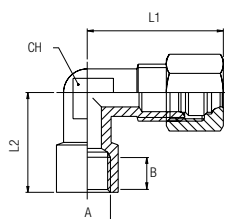

Code Brass	Code Nickel Plated Brass	Tube	A	B	L1	L2	CH	Pack.
13290 00 001	13290 00 019	4	1/8	8.5	23	18	8	10
13290 00 002	13290 00 020	6	1/8	8.5	24	18	9	10
13290 00 003	13290 00 021	6	1/4	10.5	24.5	22.5	11	10
13290 00 004	13290 00 022	8	1/8	8.5	30	21	11	10
13290 00 005	13290 00 023	8	1/4	11	30.5	25.5	13	10
13290 00 006	13290 00 024	8	3/8	10.5	31	25	14	10
13290 00 007	13290 00 025	10	1/4	11	34	25	13	10
13290 00 008	13290 00 026	10	3/8	10.5	34	25	14	10
13290 00 009	13290 00 027	10	1/2	10.5	34	27	15	10
13290 00 010	13290 00 028	12	1/4	11	36	26	14	10
13290 00 011	13290 00 029	12	3/8	10.5	36	26	14	10
13290 00 012	13290 00 030	12	1/2	10.5	36	27	15	10
13290 00 013	13290 00 031	14	1/2	10.5	39	30	18	10
13290 00 014	13290 00 032	15	1/2	10.5	39	30	18	10
13290 00 015	13290 00 033	16	1/2	10.5	41.5	30	18	10
13290 00 016	13290 00 034	18	1/2	10.5	41.5	29	20	10
13290 00 017	13290 00 035	18	3/4	14	44.5	33.5	20	10

13300

RACCORDO A L ORIENTABILE MASCHIO CON OR

ORIENTING ELBOW MALE ADAPTOR WITH OR
 WINKELVERSCHRAUBUNG (DREHBAR) MIT OR
 EQUERRE ORIENTABLE MÂLE AVEC JOINT
 RACOR A L ORIENTABLE MACHO CON TÓRICA
 CONEXÃO MACHO EM "L" ORIENTÁVEL COM O-RING

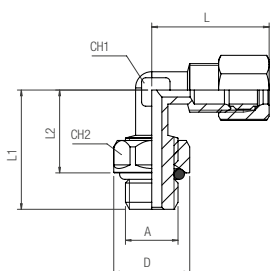

Code Brass	Tube	A	L	L1	L2	D	CH1	CH2	Pack.
13300 00 001	4	1/8	23	22.5	15.5	15	9	14	10
13300 00 002	4	1/4	23	30	19	19	9	17	10
13300 00 003	6	1/8	24.5	23	15.5	15	9	14	10
13300 00 004	6	1/4	24	21	19	19	9	17	10
13300 00 005	8	1/8	29	23	15.5	15	11	14	10
13300 00 006	8	1/4	29	29.5	19	19	11	17	10
13300 00 007	8	3/8	29.5	30.5	19	22	13	20	10
13300 00 008	10	1/4	32.5	30	19	19	13	17	10
13300 00 009	10	3/8	32.5	30.5	19	22	13	20	10
13300 00 010	10	1/2	33.5	39	24	25	17	23	10
13300 00 011	14	3/8	38.5	33.5	19	22	17	20	10
13300 00 012	14	1/2	38.5	39	24	25	17	23	10
13300 00 013	18	1/2	41.5	39.5	24	25	20	23	10
13300 00 014	18	3/4	41.5	42	25.5	32	20	30	10
13300 00 015	22	3/4	44.5	50	25.5	32	20	30	10
13300 00 016	22	1"	44.5	54	35	44	27	41	10

	min	max
	- 20 °C	+ 80 °C

13460

RACCORDO DIRITTO INTERMEDIO

STRAIGHT CONNECTOR
 VERBINDUNGSVERSCHRAUBUNG
 RACCORD UNION DOUBLE
 RACOR RECTO INTERMEDIO
 CONEXÃO RETA TUBO-TUBO

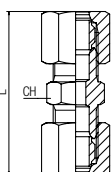

Code Brass	Code Nickel Plated Brass	Tube	L	CH	Pack.
13460 00 001	13460 00 011	4	33	10	10
13460 00 002	13460 00 012	6	36	11	10
13460 00 003	13460 00 013	8	40	13	10
13460 00 004	13460 00 014	10	45.5	16	10
13460 00 005	13460 00 015	12	47	18	10
13460 00 006	13460 00 016	14	47.5	21	10
13460 00 007	13460 00 017	15	52	21	10
13460 00 008	13460 00 018	16	52.5	22	10
13460 00 009	13460 00 019	18	56	26	10
13460 00 010	13460 00 020	22	58.5	30	10

13465

RACCORDO INTERMEDIO DI ATTRAVERSAMENTO

BULKHEAD CONNECTOR
SCHOTTVERSCHRAUBUNG
RACCORD DROIT TRAVERSÉE DE CLOISON
RACOR INTERMEDIO PASATABIQUES
CONEXÃO PASSAMURO TUBO-TUBO

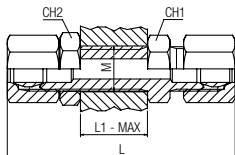

Code Brass	Code Nickel Plated Brass	Tube	L	L max	CH1	CH2	M	Pack.
13465 00 001	13465 00 007	4	49	12	10	13	M8x1	10
13465 00 002	13465 00 008	6	52.5	12.5	13	14	M10x1	10
13465 00 003	13465 00 009	8	56.5	12.5	14	17	M12x1	10
13465 00 004	13465 00 010	10	63.5	13	19	22	M16x1.5	10
13465 00 005	13465 00 011	12	70.5	17	22	22	M18x1.5	10
13465 00 006	13465 00 012	14	72.5	19	24	24	M20x1.5	10

13480

RACCORDO DIRITTO MASCHIO CONICO

STRAIGHT MALE ADAPTOR (TAPER)
GERADE EINSCHRAUBVERSCHRAUBUNG KONISCH
RACCORD DROIT MÂLE CONIQUE
RACOR RECTO MACHO CÓNICO
CONEXÃO RETA COM ROSCA MACHO CÔNICA

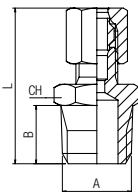

Code Brass	Code Nickel Plated Brass	Tube	A	L	CH	Pack.
13480 00 001	13480 00 024	4	1/8	26.5	11	10
13480 00 002	13480 00 025	4	1/4	29.5	14	10
13480 00 003	13480 00 026	6	1/8	28	11	10
13480 00 004	13480 00 027	6	1/4	31.5	14	10
13480 00 005	13480 00 028	6	3/8	32	17	10
13480 00 006	13480 00 029	8	1/8	30	13	10
13480 00 007	13480 00 030	8	1/4	33.5	14	10
13480 00 008	13480 00 031	8	3/8	34	17	10
13480 00 009	13480 00 032	10	1/4	36	16	10
13480 00 010	13480 00 033	10	3/8	36.5	17	10
13480 00 011	13480 00 034	10	1/2	38	21	10
13480 00 012	13480 00 035	12	1/4	37	18	10
13480 00 013	13480 00 036	12	3/8	37.5	18	10
13480 00 014	13480 00 037	12	1/2	39	21	10
13480 00 015	13480 00 038	14	3/8	37.5	20	10
13480 00 016	13480 00 039	14	1/2	40	21	10
13480 00 017	13480 00 040	15	1/2	40	21	10
13480 00 018	13480 00 041	16	1/2	42.5	22	10
13480 00 019	13480 00 042	16	3/4	44	27	10
13480 00 020	13480 00 043	18	1/2	43.5	24	10
13480 00 021	13480 00 044	18	3/4	45	27	10
13480 00 022	13480 00 045	22	1/2	46	30	10
13480 00 023	13480 00 046	22	3/4	47.5	30	10

13483

RACCORDO DIRITTO MASCHIO CILINDRICO CON OR

STRAIGHT MALE ADAPTOR WITH OR (PARALLEL)
EINSCHRAUBVERSCHRAUBUNG ZYLINDRISCH MIT OR
RACCORD DROIT AVEC JOINT TORIQUE MALE CYLINDRIQUE
RACOR RECTO MACHO CILÍNDRICO CON TÓRICA
CONEXÃO RETA COM ROSCA MACHO PARALELA COM O-RING

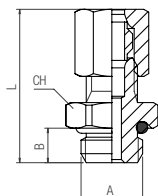

Code Brass	Code Nickel Plated Brass	Tube	A	L	B	CH	Pack.
13483 00 013	13483 00 050	4	M5	19.5	4	10	10
13483 00 014	13483 00 051	4	M8	21.5	5.5	13	10
13483 00 001	13483 00 038	4	1/8	24	5.5	13	10
13483 00 015	13483 00 052	6	M10X1	22	5.5	13	10
13483 00 016	13483 00 053	6	M10X1.5	22	5.5	13	10
13483 00 002	13483 00 039	6	1/8	25	5.5	13	10
13483 00 003	13483 00 040	6	1/4	27.5	8	16	10
13483 00 017	13483 00 054	8	M12X1	26	8	16	10
13483 00 018	13483 00 055	8	M12X1,25	26	8	16	10
13483 00 004	13483 00 041	8	1/8	27	5.5	13	10
13483 00 005	13483 00 042	8	1/4	29.5	8	16	10
13483 00 006	13483 00 043	8	3/8	30.5	8	20	10
13483 00 007	13483 00 044	10	1/4	32	8	16	10
13483 00 008	13483 00 045	10	3/8	32.5	8	20	10
13483 00 027	13483 00 064	12	1/4	33.5	8	18	10
13483 00 028	13483 00 065	12	3/8	33	8	20	10
13483 00 029	13483 00 066	12	1/2	36	9.5	25	10
13483 00 009	13483 00 046	14	3/8	34	8	22	10
13483 00 010	13483 00 047	14	1/2	36.5	9.5	25	10
13483 00 030	13483 00 067	15	3/8	34	8	22	10
13483 00 025	13483 00 062	15	1/2	37	9.5	25	10
13483 00 031	13483 00 068	16	3/8	37	8	22	10
13483 00 032	13483 00 069	16	1/2	39.5	9.5	25	10
13483 00 033	13483 00 070	18	1/2	40.5	9.5	25	10
13483 00 034	13483 00 071	18	3/4	45	11	34	10
13483 00 011	13483 00 048	22	3/4	48	11	34	10
13483 00 012	13483 00 049	22	1"	48.5	12	40	10

	min	max
Temperature	- 20 °C	+ 80 °C

13485

RACCORDO DIRITTO MASCHIO CILINDRICO

STRAIGHT MALE ADAPTOR (PARALLEL)
GERADE EINSCHRAUBVERSCHRAUBUNG ZYLINDRISCH
RACCORD DROIT MÂLE CYLINDRIQUE
RACOR RECTO MACHO CILÍNDRICO
CONEXÃO RETA COM ROSCA MACHO PARALELA

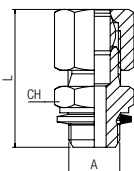

Code Brass	Tube	A	L	CH	Pack.
13485 00 001	4	1/8	26	13	10
13485 00 002	6	1/8	27	13	10
13485 00 003	6	1/4	30.5	17	10
13485 00 004	8	1/8	30	13	10
13485 00 005	8	1/4	32.5	17	10
13485 00 006	8	3/8	36.5	22	10
13485 00 007	10	1/4	35	17	10
13485 00 008	10	3/8	39	22	10
13485 00 009	14	3/8	40	22	10
13485 00 010	14	1/2	42	27	10
13485 00 011	22	3/4	49	32	10
13485 00 012	22	1"	52	40	10

	min	max
Temperature	- 20 °C	+ 80 °C

13500

RACCORDO DIRITTO FEMMINA

STRAIGHT FEMALE ADAPTOR
AUF SCHRAUBVERSCHRAUBUNG
RACCORD DROIT TARAUEE
RACOR RECTO HEMBRA
CONEXÃO RETA COM ROSCA FÊMEA

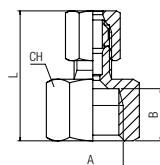

Code Brass	Code Nickel Plated Brass	Tube	A	B	L	CH	Pack.
13500 00 001	13500 00 022	4	1/8	8.5	25	14	10
13500 00 002	13500 00 023	4	1/4	11	27.5	17	10
13500 00 003	13500 00 024	6	1/8	8.5	26	14	10
13500 00 004	13500 00 025	6	1/4	11	28.5	17	10
13500 00 005	13500 00 026	8	1/8	8.5	28	14	10
13500 00 006	13500 00 027	8	1/4	11	30.5	17	10
13500 00 007	13500 00 028	8	3/8	11.5	31.5	20	10
13500 00 008	13500 00 029	10	1/4	11	33	17	10
13500 00 009	13500 00 030	10	3/8	11.5	33.5	20	10
13500 00 010	13500 00 031	10	1/2	13.5	35.5	24	10
13500 00 011	13500 00 032	12	1/4	14.5	34	18	10
13500 00 012	13500 00 033	12	3/8	11.5	34.5	20	10
13500 00 013	13500 00 034	12	1/2	13.5	34	24	10
13500 00 014	13500 00 035	14	3/8	11.5	36.5	20	10
13500 00 015	13500 00 036	14	1/2	13.5	34	24	10
13500 00 016	13500 00 037	15	1/2	13.5	36.5	24	10
13500 00 017	13500 00 038	16	1/2	13.5	39	24	10
13500 00 018	13500 00 039	16	3/4	14.5	40.5	30	10
13500 00 019	13500 00 040	18	1/2	13.5	40	24	10
13500 00 020	13500 00 041	18	3/4	14.5	41.5	30	10
13500 00 021	13500 00 042	22	3/4	14.5	41.5	30	10

13510

RACCORDO A CROCE

EQUAL CROSS
KREUZVERSCHRAUBUNG
RACCORD EN CROIX
RACOR A CRUZ
CONEXÃO TIPO CRUZETA TUBO-TUBO

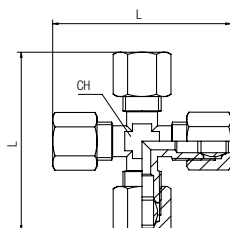

Code Brass	Code Nickel Plated Brass	Tube	L	CH	Pack.
13510 00 001	13510 00 007	4	47	8	10
13510 00 002	13510 00 008	6	48	9	10
13510 00 003	13510 00 009	8	58	11	10
13510 00 004	13510 00 010	10	66	13	10
13510 00 005	13510 00 011	12	74.5	17	10
13510 00 006	13510 00 012	14	74.5	17	10

13530

ADATTATORE ORIENTABILE MASCHIO CILINDRICO

ORIENTING MALE ADAPTOR PARALLEL
 EINSCHRAUBSTECKVERSCHRAUBUNG ZYLINDRISCH
 ADAPTATEUR D'ORIENTATION CYLINDRIQUE
 ADAPTADOR ORIENTABLE MACHO CILÍNDRICO
 ADAPTADOR ORIENTÁVEL COM ROSCA MACHO PARALELA

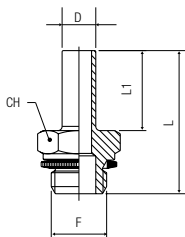

Code Brass	Code Nickel Plated Brass	D	F	L	L1	CH	Pack.
13530 00 001	13530 00 010	6	1/8	27.5	16	13	10
13530 00 002	13530 00 011	6	1/4	31	16	17	10
13530 00 003	13530 00 012	8	1/8	31.5	19	13	10
13530 00 004	13530 00 013	8	1/4	34	19	17	10
13530 00 005	13530 00 014	8	3/8	38	19	22	10
13530 00 006	13530 00 015	10	1/4	35	20	17	10
13530 00 007	13530 00 016	10	3/8	39	20	22	10
13530 00 008	13530 00 017	14	3/8	40	21	22	10
13530 00 009	13530 00 018	14	1/2	42	21	27	10

	min	max
Temperature	- 20 °C	+ 80 °C

13540

MANICOTTO PORTAGOMMA PER TUBO CAUCCIÙ

SLEEVE HOSE ADAPTER FOR CAOUTCHOUC TUBES
 SCHLAUCHTÜLLE FÜR GUMMISCHLAUCH
 DOUILLE ANNELÉE POUR TUBE CAOUTCHOUC
 MANGUITO PORTAGOMA PARA TUBO DE CAUCHO
 ESPIGÃO PARA ENGATE DE MANGUEIRAS

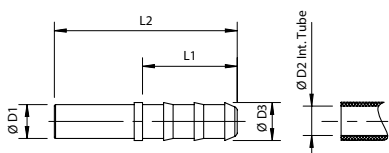

Code Brass	D1	D2	D3	L1	L	Pack.
13540 00 01 MT 00	4	4	6	22.5	39	10
13540 00 01 FM 00	6	4	6	22.5	38.5	10
13540 00 01 GG 00	6	7	9	22.5	40.5	10
13540 00 01 GF 00	8	6	8	22.5	40	10
13540 00 01 GH 00	8	7	9	22.5	43.5	10
13540 00 01 GP 00	8	10	12	22.5	43.5	10
13540 00 01 GI 00	10	7	9	22.5	44.5	10
13540 00 01 FR 00	10	10	12	22.5	44.5	10
13540 00 01 FS 00	12	10	12	22.5	45	10
13540 00 01 GM 00	12	13	15.5	29.5	52	10
13540 00 01 GN 00	14	13	15.5	29.5	52.5	10
13540 0A 01 1Q 00	14	16	18.5	38	62.5	10
13540 0A 01 1R 00	16	13	15	29.5	53.5	10
13540 00 01 Y5 00	16	16	18.5	38	64	10
13540 0A 01 1S 00	18	16	18.5	38	62	10
13540 0A 01 1T 00	18	19	21.5	38	64	10
13540 0A 01 1U 00	20	19	21.5	38	66	10
13540 0A 01 1V 00	25	19	21.5	38	70	10
13540 00 01 J4 00	25	25	27.5	38	72	10

13550

RACCORDO ORIENTABILE A L CON VITE

SINGLE BANJO BODY WITH STEM
 WINKELSCHWENKVERSCHRAUBUNG (DREHBAR)
 EQUERRE MÂLE BANJO, ORIENTABLE
 RACOR ORIENTABLE A L CON TORNILLO
 CONEXÃO EM "L" ORIENTÁVEL TIPO BANJO

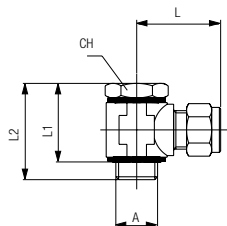

Code Brass	Code Nickel Plated Brass	Tube	A	L	L2	L1	CH	Pack.
13550 00 001	13550 00 013	4	1/8	22.5	31	24.5	14	10
13550 00 002	13550 00 014	6	1/8	23.5	31	24.5	14	10
13550 00 003	13550 00 015	6	1/4	26.5	32	25	17	10
13550 00 004	13550 00 016	8	1/8	28.5	31	24.5	14	10
13550 00 005	13550 00 017	8	1/4	28.5	32	25	17	10
13550 00 006	13550 00 018	8	3/8	30	36	27.5	19	10
13550 00 007	13550 00 019	10	1/4	32.5	32	25	17	10
13550 00 008	13550 00 020	10	3/8	32.5	36	27.5	19	10
13550 00 009	13550 00 021	14	1/4	37	44	38	17	10
13550 00 010	13550 00 022	14	3/8	37	46	38	22	10
13550 00 011	13550 00 023	14	1/2	37	49	39.5	24	10
13550 00 012	13550 00 024	22	3/4	47	64	55	32	10

	min	max
Temperature	- 20 °C	+ 80 °C

13550BI

RACCORDO ORIENTABILE A L CON VITE E RONDELLE BIMATERIALE (1613)

SINGLE BANJO BODY WITH STEM AND BIMATERIAL WASHER (1613)
 WINKELSCHWENKVERSCHRAUBUNG MIT BIMATERIAL UNTERLAGSSCHEIBE (1613)
 RACCORD BANJO MALE CYLINDRIQUE AVEC JOINT BI-MATIÈRE (1613)
 RACOR ORIENTABLE A L CON TORNILLO Y ARANDELA BIMATERIAL (1613)
 CONEXÃO EM "L" ORIENTÁVEL COM PARAFUSOS E ARRUELA BI-MATERIAL (1613)

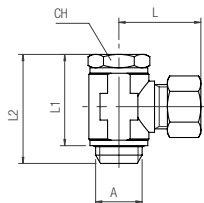

Code Brass	Tube	A	L	L2	L1	CH1	Pack.
13550 BI 001	4	1/8	22.5	31	25	14	10
13550 BI 002	6	1/8	23.5	31	25	14	10
13550 BI 003	6	1/4	26.5	32	25.5	17	10
13550 BI 004	8	1/8	28.5	31	25	14	10
13550 BI 005	8	1/4	28.5	32	26.5	17	10
13550 BI 006	8	3/8	30	36	28.5	19	10
13550 BI 007	10	1/4	32.5	32	25.5	17	10
13550 BI 008	10	3/8	32.5	36	28.5	19	10
13550 BI 027	12	1/4	37	44	38.5	17	10
13550 BI 028	12	3/8	37	46	39	19	10
13550 BI 009	14	1/4	37	44	38.5	17	10
13550 BI 010	14	3/8	37	46	39	22	10
13550 BI 011	14	1/2	37	49	41	24	10
13550 BI 029	15	3/8	37	46	39	22	10
13550 BI 030	15	1/2	37	49	41	24	10
13550 BI 031	16	1/2	39	49	41	24	10
13550 BI 032	18	1/2	45.5	49	41	24	10
13550 BI 012	22	3/4	47	64	55	32	10

	min	max
Temperature	- 30 °C	+ 100 °C

13570BI

RACCORDO ORIENTABILE A T CON VITE E RONDELLE BIMATERIALE (1613)

DOUBLE BANJO BODY WITH STEM AND BIMATERIAL WASHER (1613)
 DOPPELSCHWENKVERSCHRAUBUNG MIT BIMATERIAL UNTERLAGSSCHEIBE (1613)
 RACCORD BANJO DOUBLE MALE CYLINDRIQUE AVEC JOINT BI-MATIÈRE (1613)
 RACOR ORIENTABLE A T CON TORNILLO Y ARANDELA BIMATERIAL (1613)
 CONEXÃO EM "T" ORIENTÁVEL COM PARAFUSOS E ARRUELA BI-MATERIAL (1613)

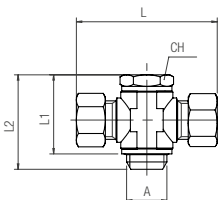

Code Brass	Tube	A	L	L2	L1	CH1	Pack.
13570 BI 001	4	1/8	45	31	25	14	10
13570 BI 002	6	1/8	47	31	25	14	10
13570 BI 003	6	1/4	53	32	25.5	17	10
13570 BI 004	8	1/8	57	36	25	14	10
13570 BI 005	8	1/4	57	32	26.5	17	10
13570 BI 006	8	3/8	60	36	28.5	19	10
13570 BI 007	10	1/4	63	32	25.5	17	10
13570 BI 008	10	3/8	65	36	28.5	19	10
13570 BI 027	12	1/4	73	44	38.5	17	10
13570 BI 028	12	3/8	73	46	39	19	10
13570 BI 009	14	1/4	73	44	38.5	17	10
13570 BI 010	14	3/8	73	46	39	22	10
13570 BI 011	14	1/2	73	49	41	24	10
13570 BI 029	15	3/8	73	46	39	22	10
13570 BI 030	15	1/2	73	49	41	24	10
13570 BI 031	16	1/2	78	49	41	24	10
13570 BI 032	18	1/2	91	49	41	24	10
13570 BI 012	22	3/4	93	64	55	32	10

	min	max
Temperature	- 30 °C	+ 100 °C

13958BI

REGOLATORE UNIDIREZIONALE ORIENTABILE PER CILINDRO

ORIENTING FLOW REGULATOR FOR CYLINDER
 DURCHFLOSSREGLER ABLUFTDROSSELUNG (DREHBAR)
 RÉGULATEUR DE DÉBIT À L'ÉCHAPPEMENT FILETAGE (ORIENTABLE)
 REGULADOR UNIDIRECCIONAL ORIENTABLE PARA CILINDRO
 REGULADORA UNIDIRECCIONAL ORIENTÁVEL PARA CILINDRO

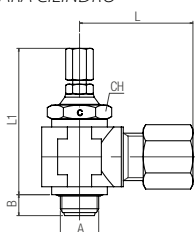

Code Brass	Tube	A	L	L1min	L1max	B	CH1	Pack.
13958 BI 001	8	1/8	28.5	36.5	42	4.5	14	10
13958 BI 002	10	1/4	32.5	40	45.5	6.5	17	10
13958 BI 003	14	3/8	36.5	50	57	6.5	20	10
13958 BI 004	18	1/2	46	54.5	62	7.5	24	10

Regolatore (8905) + Rondelle bimateriale (1613).
 Regulator (8905) + Bimaterial washer (1613).
 Regler (8905) + Bimaterial unterlagsscheibe (1613).
 Régulateur (8905) + Joint bi matière (1613).
 Regulador (8905) + Arandela bimaterial (1613).
 Reguladora (8905) + Arruela bi-material (1613).

	min	max
Temperature	- 20 °C	+ 80 °C

Regolazione manuale - Manual regulation - Einstellbar von hand
 À vis extérieur - regulación manual - regulagem manual

13600

RIDUZIONE

REDUCTION
REDUZIERUNG
RÉDUCTION
REDUCCIÓN
REDUÇÃO

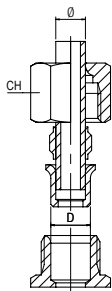

Code Brass	Code Nickel Plated Brass	Tube	D	CH	Pack.
13600 00 001	13600 00 006	4	6	13	10
13600 00 002	13600 00 007	6	8	14	10
13600 00 003	13600 00 008	8	10	19	10
13600 00 004	13600 00 009	10	12	22	10
13600 00 005	13600 00 010	12	14	24	10

Questo articolo è comprensivo di tre particolari quali: Dado, Ogiva, Riduzione.

This article is comprehensive of 3 parts: Nut, Olive, Reduction.

Dieser Artikel enthält drei wie insbesondere: Mutter, Spinner, Verringerung.

Cet article comprend trois des détails tels que: Écrous, Spinner, Réduction.

Este artículo incluye tres partes: Tuerca, Ojiva, Reducción.

Este artigo inclui três especial, tais como: Nut, Girador, Redução.

13680

DADO

NUT
ÜBERWURFMUTTER
ECROU
TUERCA
PORCA

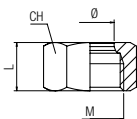

Code Brass	Code Nickel Plated Brass	Tube	L	CH	M	Pack.
13680 00 01 X1 00	13680 00 01 X1 NB	4	10.5	10	M 8x1	50
13680 00 01 X4 00	13680 00 01 X4 NB	6	10.5	13	M 10x1	50
13680 00 01 X7 00	13680 00 01 X7 NB	8	12.5	14	M 12x1	50
13680 00 01 X9 00	13680 00 01 X9 NB	10	15	19	M 16x1.5	50
13680 00 01 Y1 00	13680 00 01 Y1 NB	12	15	22	M 18x1.5	50
13680 00 01 Y3 00	13680 00 01 Y3 NB	14	15	24	M 20x1.5	20
13680 00 01 Y4 00	13680 00 01 Y4 NB	15	15	24	M 20x1.5	20
13680 00 01 Y5 00	13680 00 01 Y5 NB	16	17	27	M 22x1.5	20
13680 00 01 Y7 00	13680 00 01 Y7 NB	18	18	30	M 24x1.5	20
13680 00 01 J1 00	13680 00 01 J1 NB	22	19	36	M 30x1.5	10

13740

OGIVA OTTONE

BRASS OLIVE
KLEMMRING MESSING
OLIVE LAITON
BICONO LATÓN
BUCHA EM LATÃO

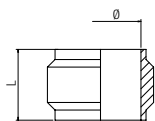

Code Brass	Tube	L	Pack.
13740 00 01 X1 00	4	6	50
13740 00 01 X4 00	6	6.5	50
13740 00 01 X7 00	8	7	50
13740 00 01 X9 00	10	8	50
13740 00 01 Y1 00	12	8.5	50
13740 00 01 Y3 00	14	8.5	20
13740 00 01 Y4 00	15	8.5	20
13740 00 01 Y5 00	16	9	20
13740 00 01 Y7 00	18	9.5	20
13740 00 01 J1 00	22	10	10

13780

TAPPO PER RACCORDI UNIVERSALI

PLUG FOR UNIVERSAL FITTINGS
STOPFEN FÜR DOPPELKEGEL VERSCHRAUBUNGEN
BOUCHON POUR RACCORDES UNIVERSELS
TAPÓN PARA RACORES UNIVERSALES
TAMPÃO PARA CONEXÃO UNIVERSAIS

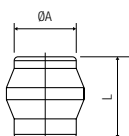

Code Brass	Tube	L	Pack.
13780 00 01 X1 00	4	10	50
13780 00 01 X4 00	6	10.5	50
13780 00 01 X7 00	8	10.5	50
13780 00 01 X9 00	10	11.5	50
13780 00 01 Y1 00	12	12	50
13780 00 01 Y3 00	14	14	20
13780 00 01 Y4 00	15	14	20
13780 00 01 Y5 00	16	14	20
13780 00 01 Y7 00	18	16	20
13780 00 01 J1 00	22	15	20

10740

OGIVA OTTONE

BRASS OLIVE
KLEMMRING MESSING
OLIVE LAITON
BICONO LATÓN
BUCHA DE LATÃO

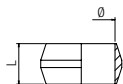

Code Brass	Tube	L	Pack.
10740 00 02 X1 00	4	5.5	50
10740 00 02 X4 00	6	6.5	50
10740 00 02 X7 00	8	6.5	50
10740 00 02 X9 00	10	7.5	50
10740 00 02 Y1 00	12	8	50
10740 00 02 Y3 00	14	8.5	20
10740 00 02 Y4 00	15	9	20
10740 00 02 Y5 00	16	9.5	20
10740 00 02 Y7 00	18	10	20
10740 00 02 J1 00	22	10	10

10770

BUSSOLA DI RINFORZO

INTERNAL SUPPORT BUSH
STÜTZHÜLSE MESSING
FOURRURE INTÉRIEURE
REFUERZO
BUCHA DE REFORÇO INTERNA

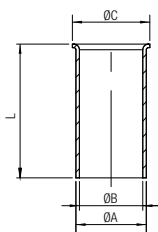

Code Brass	Tube	A	B	C	L	Pack.
10770 00 01 1D 00	4/2.7	2.7	2.1	3.7	13	10
10770 00 01 3D 00	6/4	4	3.2	5	13	10
10770 00 01 4D 00	8/6	6	5	7	16.5	10
10770 00 01 5D 00	10/8	8	7	9	17	10
10770 00 01 7D 00	12/9	9	8	11	19	10
10770 00 01 8D 00	12/10	10	9	11	19	10
10770 00 01 0E 00	14/12	12	11	13.5	21	10
10770 00 01 1E 00	15/12.5	12.5	11.6	14	21	10
10770 00 01 3E 00	16/13	13	12	15.5	22	10
10770 00 01 7E 00	18/15	15	14	17.5	23	10
10770 00 01 8E 00	18/16	16	15	17.5	23	10
10770 00 01 0F 00	22/18	18	17	21	25	10

1612

RONDELLA BIMATERIALE IN ACCIAIO E NBR

STEEL AND NBR BIMATERIAL WASHER
VERBUNDDICHTRINGE AUS STAHL UND NBR
RONDELLE-JOINT BI-MATIÈRE (NBR/ACIER)
ARANDELA BIMATERIAL EN ACERO Y NBR
ARRUELA BI-MATERIAL EM AÇO E NBR

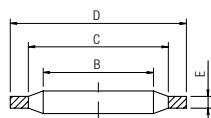

Code	Size	B	C	D	E	Pack.
01612 00 001	1/8	10.4	12	14.7	1.25	20
01612 00 002	1/4	13.85	15.75	18.7	1.25	20
01612 00 003	3/8	17.35	19.25	22.7	1.25	20
01612 00 004	1/2	21.65	23.55	26.7	1.25	20
01612 00 005	3/4	27.3	29.2	32.5	1.25	20
01612 00 006	1"	34.2	36.1	39.5	2	20



Temperature

min - 30 °C
max + 100 °C

1613

RONDELLA AUTOCENTRANTE BIMATERIALE IN ACCIAIO E NBR

STEEL AND NBR CENTERING BIMATERIAL WASHER
BI-MATERIAL STAHL SCHEIBE UND NBR
RONDELLE JOINT BI-MATIÈRE (NBR/ACIER)
ARANDELA BIMATERIAL EN ACERO Y NBR
ARRUELA BI-MATERIAL EM AÇO E NBR

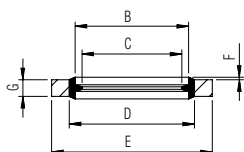

Code	Size	B	C	D	E	G	F	Pack.
01613 00 001	1/8	10.37	8.56	11.84	14	2	0.3	20
01613 00 002	1/4	13.74	11.45	15.21	17	2	0.3	20
01613 00 003	3/8	17.28	14.96	18.75	22	2	0.3	20
01613 00 004	1/2	21.54	18.64	23.01	26	2.5	0.4	20
01613 00 005	3/4	27.05	24.13	28.53	32	2.5	0.4	20
01613 00 006	1"	33.89	30.30	36.88	41	3.2	0.5	20



Temperature

min - 30 °C
max + 100 °C

RACCORDO PORTAGOMMA PER TUBO AUTOBLOCCANTE

HOSE ADAPTER FOR LOCKING HOSE SELF
 EINSCHRAUBTÜLLE FÜR STECKSCHLÄUCHE
 DOUILLES ANNELÉES RAPIDES POUR TUYAUX AUTO-SERRANTS
 RACORDAJE PORTAGOMA PARA TUBO AUTOBLOCCANTE
 CONEXÃO ESPIGAO PARA TUBO AUTOBLOCCANTE

13800

RACCORDO PORTAGOMMA FEMMINA PER TUBO AUTOBLOCCANTE

FEMALE HOSE ADAPTER FOR LOCKING HOSE SELF
 SCHNELLSTECKTÜLLE FÜR UNIVERSAL VERSCHSCHRAUBUNG
 ÉCROU R.U. AVEC DOUILLE ANNELEE POUR TUYAUX AUTO-SERRANTS
 RACORDAJE PORTAGOMA HEMBRA PARA TUBO AUTOBLOCCANTE
 CONEXÃO ESPIGÃO FÊMEA PARA TUBO AUTOBLOCCANTE

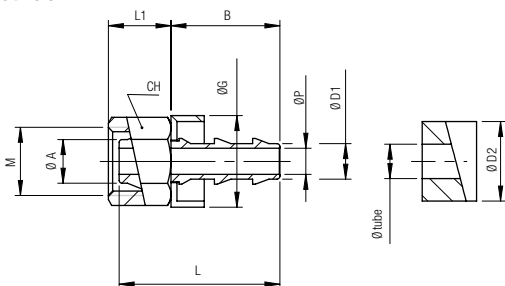

Montaggio
 Assembling
 Montageanleitung
 Assemblage
 Montaje
 Montagem

Code	Tube	M	Ø A	Ø D1	Ø D2	CH	Ø G	L	B	L1	Ø P	Pack.
13800 00 001	1/4	M10x1	6	6.5	13	12	16.7	32.5	20	11.5	4.8	10
13800 00 002	1/4	M12x1	8	6.5	13	14	16.7	29.5	20	12.5	4.8	10
13800 00 003	1/4	M16x1.5	10	6.5	13	19	16.7	30.5	24	14	4.8	10
13800 00 004	3/8	M16x1.5	10	9.5	16	19	19.5	34.5	24	14	7.5	10
13800 00 005	3/8	M20x1.5	14	9.5	16	24	19.5	36	28	14	7.5	10
13800 00 006	1/2	M20x1.5	14	12.7	19	24	23.5	40	28	14	10	10
13800 00 010	1/2	M22x1.5	16	12.7	19	27	23.5	44	28.5	15.5	10	10
13800 00 007	1/2	M24x1.5	18	12.7	19	30	23.5	40.5	36.5	17	10	10
13800 00 008	5/8	M24x1.5	18	15.7	23	30	27.3	49	36.5	17	13.5	10
13800 00 009	3/4	M30x1.5	22	18.8	27	36	30.8	57.5	43	17	16	10



IT

Su ogni articolo della serie 13000 è possibile sostituire dado e ogiva con 13800. Vedi "Ø A" come riferimento.

GB

For each item of the 13000 serie, you can remove the nut and the olive and connect with the art. 13800. See "Ø A" for nut size.

DE

Auf jedes Artikel der Serie 13000 kann man die Überwurfmutter und Klemmring mit dem Artikel 13800 ersetzen. Für die Auswahl Siehe "Ø A" Rohrdurchmesser.

FR

Pour chaque article de la série 13000, possibilité de substituer l'écrouet l'ogive avec le code 13800. Se reporter au "Ø A" pour diamètre écrou.

ES

Para cada artículo de la serie 13000 es posible de sustituir la tuerca y el bicono con 13800. Ver "Ø A" como referencia.

PT

Para cada item da série 13000 é possível fazer a substituição da porca e da anilha pelo item 13800. Veja "Ø A" para referência.

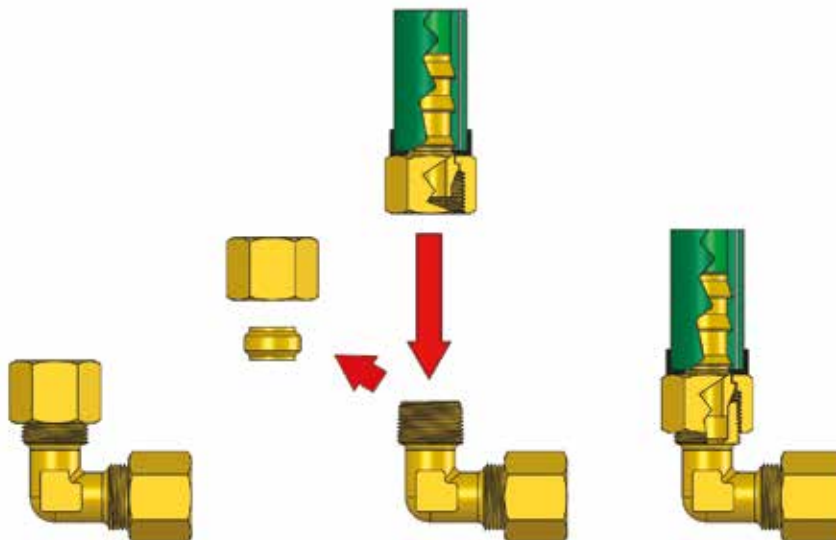

13805

RACCORDO PORTAGOMMA FEMMINA PER TUBO AUTOBLOCCANTE

FEMALE HOSE ADAPTER FOR LOCKING HOSE SELF

SCHNELLSTECKTÜLLEN FÜR STECKSCHLÄUCHE

DOUILLES ANNELÉES RAPIDES POUR TUYAUX AUTO-SERRANTS

RACORDAJE PORTAGOMA HEMBRA PARA TUBO AUTOBLOCCANTE

CONEXÃO ESPIGÃO FÊMEA PARA TUBO AUTOBLOCCANTE

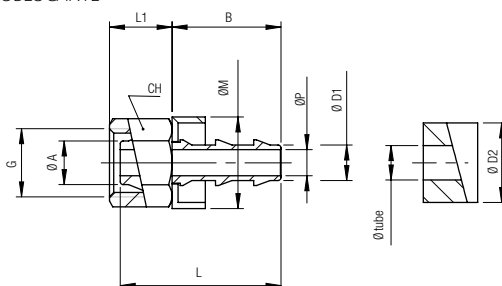

Montaggio
Assembling
Montageanleitung
Assemblage
Montaje
Montagem

Code	Tube	G (Gas)	Ø A	Ø D1	Ø D2	CH	Ø M	L	B	L1	Ø P	Pack.
1380500002	1/4	1/4	8	6.5	13	15	16.7	29.5	20	12.5	4.8	10
1380500003	1/4	3/8	10	6.5	13	19	16.7	30.5	24	15	4.8	10
1380500004	3/8	3/8	10	9.5	16	19	19.5	34.5	24	15	7.5	10
1380500005	3/8	1/2	14	9.5	16	24	19.5	36	28	15	7.5	10
1380500006	1/2	1/2	14	12.7	19	24	23.5	40	28	15	10	10
1380500008	5/8	3/4	18	15.7	23	32	27.3	49	36.5	16.5	13.5	10
1380500009	3/4	3/4	18	18.7	27	32	30.8	57.5	43	18	13.5	10

13810

RACCORDO PORTAGOMMA MASCHIO PER TUBO AUTOBLOCCANTE

MALE HOSE ADAPTER FOR LOCKING HOSE SELF

SCHNELLSTECKTÜLLE MIT AUSSENGEWINDE

DOUILLE ANNELEE RAPIDE POUR TUYAUX AUTO-SERRANTS

RACORDAJE PORTAGOMA MACHO PARA TUBO AUTOBLOCCANTE

CONEXÃO ESPIGÃO MACHO PARA TUBO AUTOBLOCCANTE

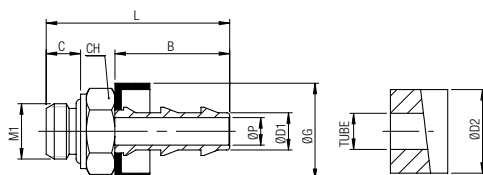

New

Montaggio
Assembling
Montageanleitung
Assemblage
Montaje
Montagem

Code	Tube	M1	Ø D1	Ø D2	CH	Ø G	L	B	C	Ø P	Pack.
13810 00 001	1/4	1/8	6.5	13	13	16.7	32	20	6	4.8	10
13810 00 002	1/4	1/4	6.5	13	17	16.7	35.5	20	8	4.8	10
13810 00 003	3/8	1/4	9.5	16	17	19.5	39.5	24	8	7.5	10
13810 00 004	3/8	3/8	9.5	16	22	19.5	41	24	9	7.5	10
13810 00 005	1/2	3/8	12.7	19	22	23.5	45	28	9	10	10
13810 00 006	1/2	1/2	12.7	19	27	23.5	47	28	10	10	10
13810 00 007	5/8	1/2	15.7	23	27	27.3	55	36.5	10	13.5	10
13810 00 008	5/8	3/4	15.7	23	32	27.3	58.5	36.5	12	13.5	10
13810 00 019	3/4	1/2	18.8	27	30	30.8	65	43	10	16	10
13810 00 009	3/4	3/4	18.8	27	32	30.8	65	43	12	16	10

13820

NIPPLO
 NIPPLE
 DOPPELNIPPEL
 MAMELON
 MACHÓN
 NIPLE

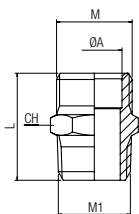

Montaggio con 13800
 Assembling with 13800
 Montageanleitung mit 13800
 Assemblage avec 13800
 Montaje con 13800
 Montagem com 13800

Code	M	M1	Ø A	L	CH	Pack.
13820 00 001	M10x1	1/8	6	20	11	10
13820 00 002	M10x1	1/4	6	23.5	14	10
13820 00 003	M10x1	3/8	6	24	17	10
13820 00 004	M12x1	1/8	8	20.5	13	10
13820 00 005	M12x1	1/4	8	24	14	10
13820 00 006	M12x1	3/8	8	24.5	17	10
13820 00 007	M16x1.5	1/4	10	26	16	10
13820 00 008	M16x1.5	3/8	10	26.5	17	10
13820 00 009	M16x1.5	1/2	10	28	21	10
13820 00 010	M20x1.5	3/8	14	26.5	20	10
13820 00 011	M20x1.5	1/2	14	29	21	10
13820 00 016	M22x1.5	1/2	16	31	22	10
13820 00 012	M24x1.5	1/2	18	31	24	10
13820 00 013	M24x1.5	3/4	18	32.5	27	10
13820 00 014	M30x1.5	3/4	22	33.5	30	10
13820 00 015	M30x1.5	1/2	22	32	30	10

13825

NIPPLO
 NIPPLE
 DOPPELNIPPEL
 MAMELON
 MACHÓN
 NIPLE

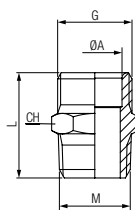

Montaggio con 13805
 Assembling with 13805
 Montageanleitung mit 13805
 Assemblage avec 13805
 Montaje con 13805
 Montagem com 13805

Code	G (Gas)	M	Ø A	L	CH	Pack.
13825 00 01 03 00	1/4	1/4	8	24	14	10
13825 00 01 04 00	3/8	3/8	10	26.5	17	10
13825 00 01 05 00	1/2	1/2	14	29	22	10
13825 00 01 07 00	3/4	3/4	18	32.5	27	10

TUBO AUTOBLOCCANTE

PUSH-LOCK HOSE
SCHNELLSTECKSCHLÄUCHE
TUYAUX AUTO-SERRANTS
TUBERÍA AUTOBLOCANTE
TUBO PUSH-LOCK



CARATTERISTICHE TECNICHE

TECHNICAL CHARACTERISTICS
TECHNISCHE ANGABEN
CARACTÉRISTIQUES TECHNIQUES
CARACTERÍSTICAS TÉCNICAS
CARACTERÍSTICAS TÉCNICAS

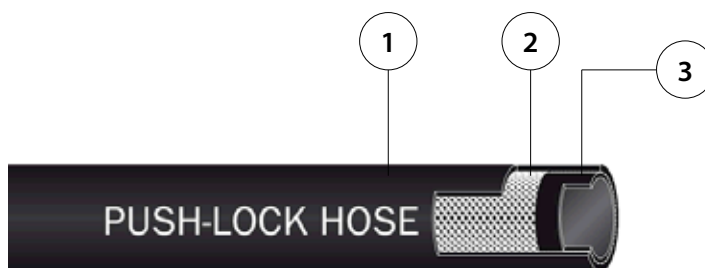

Materiali	IT	Materials	GB	Materialien	DE
1 Sottostrato: NBR/PVC liscio resistente agli oli.		1 Sublayer: NBR/PVC smooth, oil resistant.		1 Innenrohr: NBR/PVC glatt, Öl.	
2 Armatura: Tela Tessile.		2 Armor: Cloth Textiles.		2 Gewebeeinlage: Synthetische Textilfasern.	
3 Rivestimento: NBR/PVC liscio resistente alle abrasioni, agli oli e agli agenti atmosferici.		3 Finish: NBR/PVC smooth, abrasion, oil and weather resistant.		3 Aussenschicht: NBR/PVC glatt, Abriebfest, Öl- und Witterungsbeständig.	
Matériaux	FR	Materials	ES	Materials	PT
1 Tube: NBR/PVC lisse, résistant aux huiles.		1 Tubo interior: NBR/PVC liso resistente a los aceites.		1 Tubo interior: NBR/PVC suave resistente a óleos.	
2 Armature: Fibres textiles.		2 Armadura: Trenza Textil		2 Armadura: Traçado Têxtil	
3 Revêtement extérieur: NBR/PVC lisse, résistant à l'abrasion, aux huiles et aux intempéries.		3 Tubo exterior: NBR/PVC liso resistente a la abrasión, a los aceites y a los agentes atmosféricos.		3 Tubo exterior: NBR/PVC suave resistência a abrasão, a óleos, a agentes atmosférico.	

COLORI STANDARD
STANDARD COLORS
STANDARD FARBEN
COULEURS STANDARDS
CORES STANDARD
CORES PADRÃO

	RO	ROSSO RED ROT ROUGE ROJO VERMELHO
	BL	AZZURRO LIGHT BLUE HELLBLAU BLEU CLAIR AZUL AZUL CLARO
	VE	VERDE GREEN GRÜN VERT VERDE VERDE
	NE	NERO BLACK SCHWARZ NOIR NEGRO PRETO



Temperatura con aria compressa Temperature with compressed air Mit Druckluft Avec de l'air comprimé Con aire comprimido Com ar comprimido	-20°C	+110°C con picchi di 125°C peak +125°C Kurzfristig +125°C Pic à +125°C con picos de +125 °C com picos de +125 °C
Temperatura con acqua Temperature with water Mit Wasser Avec de l'eau Con Agua Com Água	0°C	+100°C con picchi di 110°C peak +110°C Kurzfristig +110°C Pic à +110°C con picos de +110 °C com picos de +110 °C
Temperatura con olio idraulico Temperature with hydraulic oil Mit Hydrauliköl Avec de l'huile hydraulique Con aceites hidráulicos Com óleos hidráulicos	-20°C	+70°C con picchi di 90°C peak +90°C Kurzfristig +90°C Pic à +90°C con picos de +90 °C com picos de +90 °C
Temperatura con Acqua Glicole Temperature with Water Glycol Mit Glykolwasser Avec de l'eau glycolé Con Agua Glicol Com Água e Glicol	-20°C	+70°C con picchi di 90°C peak +90°C Kurzfristig +90°C Pic à +90°C con picos de +90 °C com picos de +90 °C



Pressioni

Pressures

Druckbereich

Pressions

Presiones

Pressões

16 bar (1.6 MPa)



Fluidi compatibili

Aria compressa / Acqua / Olio Idraulico / Acqua Glicole / Gasolio / Benzina

Fluids

Compressed air / Water / Hydraulic Oil / Water Glycol / Diesel Fuel / Petrol

Geeignete Medien

Druckluft / Wasser / Hydrauliköl / Glykolwasser / Dieselkraftstoff / Benzin

Fluides compatibles

Air comprimé / Eau / Huile Hydraulique / Eau glycolé / Carburant diesel / Essence

Fluidos compatibles

Aire comprimido / Agua / Aceite hidráulico / Agua Glicol / Combustible Diesel / Gasolina

Fluidos compatíveis

Ar comprimido / Água / Óleo hidráulico / Água e Glicol / Combustível Diesel / Gasolina

TBPL

TUBO AUTOBLOCCANTE

PUSH-LOCK HOSE





SCHNELLSTECKSCHLÄUCHE

TUYAUX AUTO-SERRANTS

TUBERÍA AUTOBLOCANTE

TUBO PUSH-LOCK



Code	Code	Code	Code	Int.	Int.	Est.	Raggio di curvatura Bending Radius Biegeradius Rayon de Courbure Radio Curvatura Raio de Curvatura	Pressione d'esercizio Working Pressure Betriebsdruck Pression de Travail Presión de Ejercicio Pressão de Trabalho	Pressione di scoppio Burst Pressure Berstdruck Pression d'Éclatement Presión de Rótura Pressão de Ruptura	Pack.
				inch	mm	mm	mm	a/at 23°C bar	a/at 23°C bar	Mt
TBPL 1/4 0 RO 100	TBPL 1/4 0 BL 100	TBPL 1/4 0 VE 100	TBPL 1/4 0 NE 100	1/4	6.3	12.4	45	16	64	100
TBPL 3/8 0 RO 100	TBPL 3/8 0 BL 100	TBPL 3/8 0 VE 100	TBPL 3/8 0 NE 100	3/8	9.6	15.5	75	16	64	100
TBPL 1/2 0 RO 100	TBPL 1/2 0 BL 100	TBPL 1/2 0 VE 100	TBPL 1/2 0 NE 100	1/2	12.7	18.7	90	16	64	100
TBPL 5/8 0 RO 080	TBPL 5/8 0 BL 080	TBPL 5/8 0 VE 080	TBPL 5/8 0 NE 080	5/8	16	22.9	115	16	64	80
TBPL 3/4 0 RO 080	TBPL 3/4 0 BL 080	TBPL 3/4 0 VE 080	TBPL 3/4 0 NE 080	3/4	19.2	26.5	135	16	64	80